

Article number: 0101110
 Description: Retaining ring A 125 DIN 471
 Spring steel
 Note: Fitted with ZGA pilers

Measures

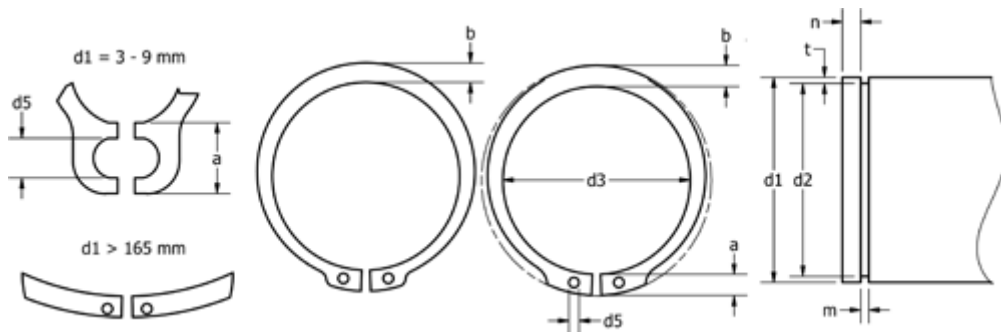

a max	= 11.4	FN kN	= 128.0	s	= 4.00
AN mm ²	= 772.0	FRg kN	= 56.50	t	= 2.00
b	= 10.4	FR kN	= 411.00	tol	= -0.63
d1	= 125	g	= 4.0	tol	= -0.10
d2	= 121.0	K kN-mm	= 870.00	tol	= +0,54-1,30
d3	= 118.0	m min	= 4.15	Tong	= ZGA-5
d5 min	= 4.0	n abl x 1000	= 3.0	Weight kg/1000	= 90.000
Description	= A125	Nominal drive	= 6.0		